

CLOISONFLEX

Tel. : 01 69 09 24 93

Fax. : 01 69 09 77 18

Mail : contact@cloisonflex.fr

1

Parclose huisserie ref. 150

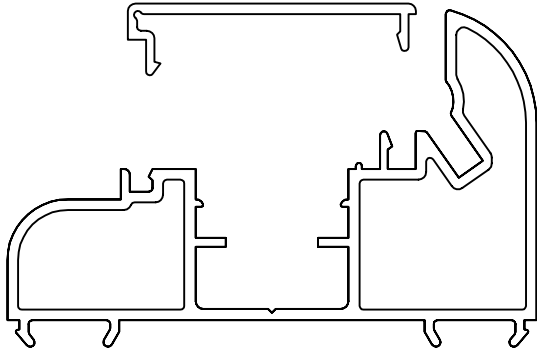

Huisserie ref. 210

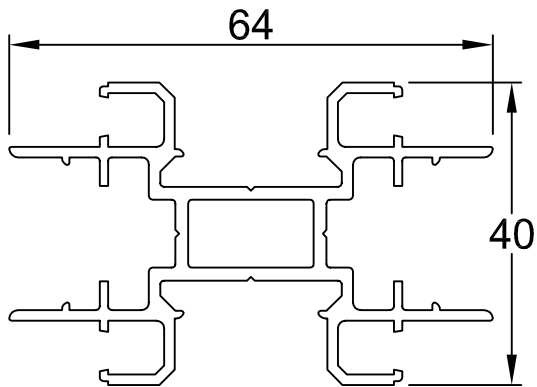

Poteau ref. 100

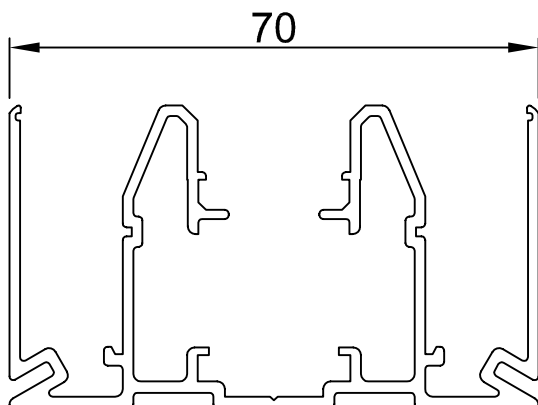

Lisse ref. 110

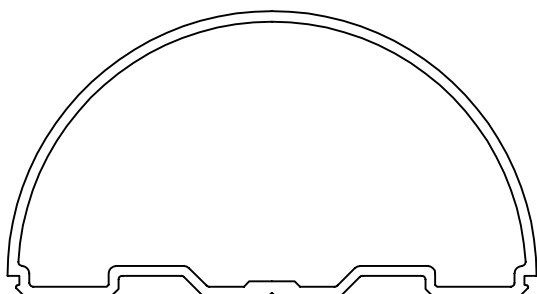

Demi tube ref. 185

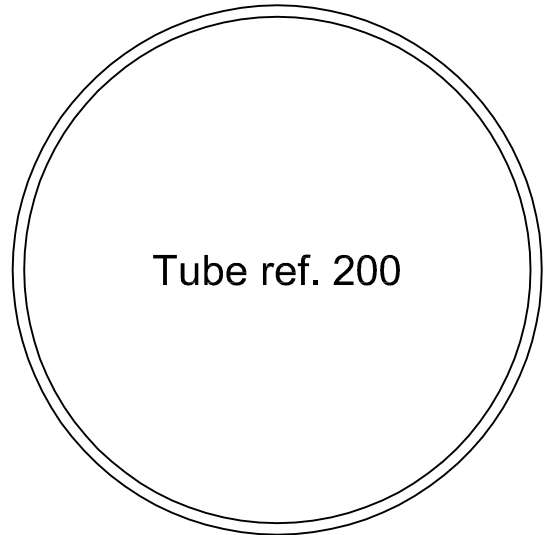

Tube ref. 200

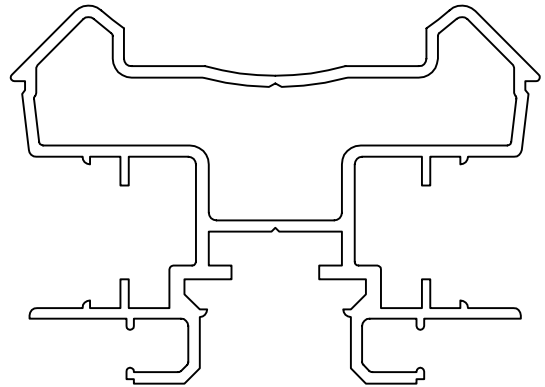

Poteau d'angle ref. 165

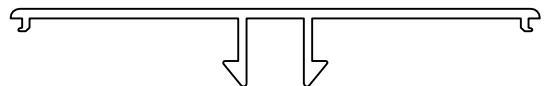

Finition ref. 180

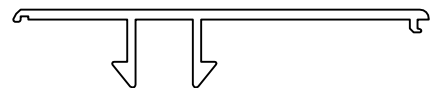

Parclose simple vitrage ref. 130

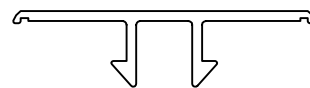

Couvre-joint ref. 120

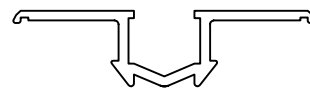

Couvre-joint creux ref. 170